

Systems of Proportion in Design and Architecture and their Relationship to Dynamical Systems Theory

Jay Kappraff
Mathematics Department
New Jersey Institute of Technology
Newark, NJ 07102.
Kappraff@aol.com

Abstract

A general theory of proportion is presented and applied to proportional systems based on the golden mean, root 2, and root 3. These proportions are shown to be related to regular star polygons and to the law of repetition of ratios. The additive properties of these proportions are presented in terms of both irrational and integer series. The geometrical and number theoretic properties of the root 3 system are focused on since this system has not been previously reported in the literature. An architectural Rotunda is presented. The relationship between systems of proportion and the symbolic dynamics of chaos theory is presented.

1. Introduction

Architecture and design have always involved a search for general laws of beauty. Is beauty in the eye of the beholder or does it come about through intrinsic properties of space? Three general principles: repetition, harmony, and variety lie at the basis of beautiful designs. Repetition is achieved by using a system that provides a set of proportions that are repeated in a design or building at different scales. Harmony is achieved through a system that provides a small set of lengths or modules with many additive properties which enables the whole to be created as the sum of its parts while remaining entirely within the system. Variety is provided by a system that provides a sufficient degree of versatility in its ability to tile the plane with geometric figures. Any system that provides the means to attain these objectives has a chance to produce designs of interest.

In order to achieve these objectives, architects through the ages have used various systems of proportion. A system based on $\sqrt{2}$ was used to create ancient Roman architecture [Kappraff 1996a, b]. There is evidence that this root 3 system was employed during the Renaissance by Michelangelo in his creation of the Medici Chapel [Williams 1997]. A system of proportion based on the musical scale was used during the Renaissance by the architects Leon Battista Alberti and Andreas Palladio [Wittkover 1971], [Kappraff 1991]. In modern times Le Corbusier created a successful system of proportions referred to as the Modulor based on the golden mean ϕ where $\phi = (1 + \sqrt{5})/2$ [Le Corbusier 1968], [Kappraff 1991], [Kappraff 1996a, b]. In this paper we shall present the mathematics behind a system of proportions based on $\sqrt{3}$. There is evidence that Andreas Palladio used this system in his architecture [Wassell 1998]. We shall develop the mathematics and geometry of the root 3 system within the context of a general theory of systems of proportion. It will be shown that each system of proportions gives rise to a series of 1's and 0's referred to in the study of dynamical systems as symbolic dynamics. Proportional systems based on ϕ , $\sqrt{2}$, and $\sqrt{3}$ were the principal systems used to create the buildings and designs of antiquity [Kappraff 1996], [Nicholson 1998]. We shall show that these proportions provide the simplest systems exhibiting the properties of repetition and harmony. Root 2 and root 3 geometries also have connections to the symmetry groups of the plane [Coxeter 1973].

2. Stars

The proportions relevant to a system of proportionality make their appearance as a pair of ratios: 1) the ratio in which the edges of a regular star polygon intersect, and 2) the ratio of the longest diagonal of a regular polygon to the length of the side. A star polygon with n vertices in which each vertex connects to the p -th vertex rotated from it in a clockwise direction is denoted by $\{n, p\}$. If n and p are relatively prime, the star polygon can be drawn in a single stroke without taking pencil off paper. In Figure 1a the edges of a star pentagon $\{5, 2\}$ intersect each other in the golden section $\phi : 1$ while the ratio of diagonal to edge length of a regular pentagon is also $\phi : 1$. In Figure 1b the edges incident to consecutive vertices of the star octagon $\{8, 3\}$ intersect in the ratio of $\theta : 1$ where $\theta = 1 + \sqrt{2}$ while the ratio of diagonal to edge of the octagon is also $\theta : 1$. The proportions of the root 3 system is determined by the intersection of consecutive edges of a star dodecagon $\{12, 5\}$ which intersect in the ratio $\psi : 1$ where $\psi = 1 + \sqrt{3}$. The ratio of the longest diagonal to the edge of a dodecagon is $\beta : 1$ where $\beta = 2 + \sqrt{3} = \psi^2/2$. This presents a second proportion of importance to the root 3 system.

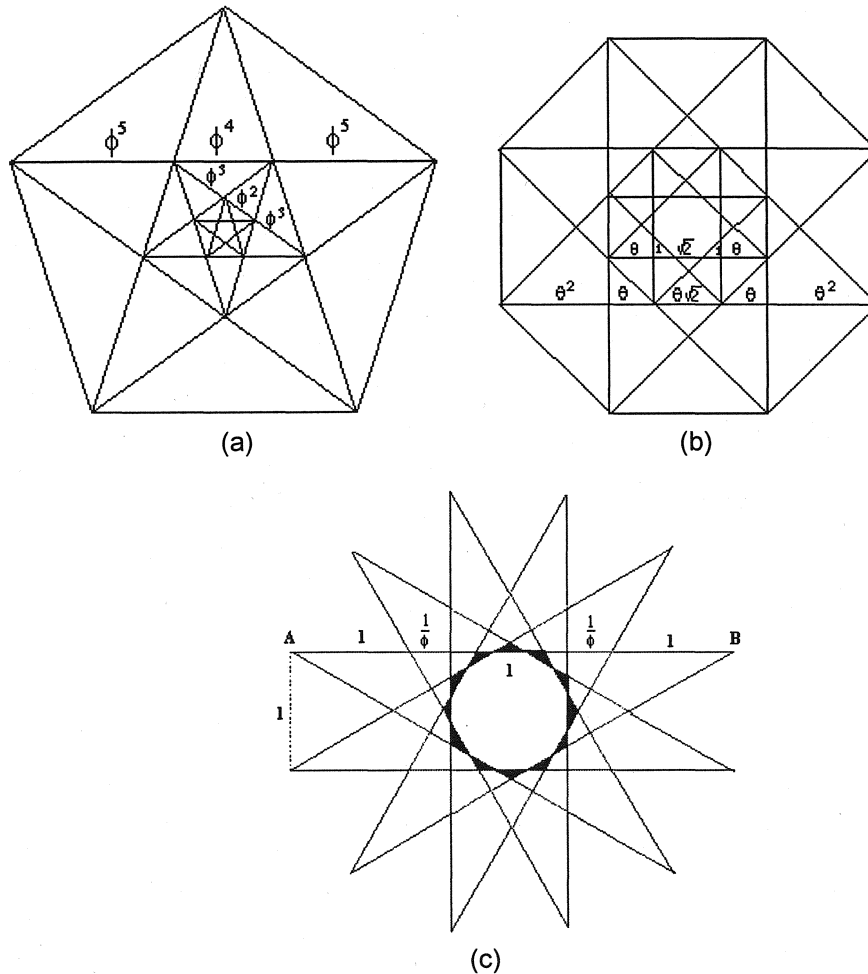

Figure 1: a) Diagonals of a star pentagon intersect in the golden ratio ($\phi:1$); b) diagonals of star octagon intersect in the sacred cut ratio ($\theta:1$); c) diagonals of a 12-pointed star intersect in the ratio of ($\psi:1$).

3. The Law of Repetition of Ratios

During the Renaissance, a simple geometric principle was used to create duplicates of a given proportion at a reduced scale as illustrated in Figure 2 for Santa Maria Novella.

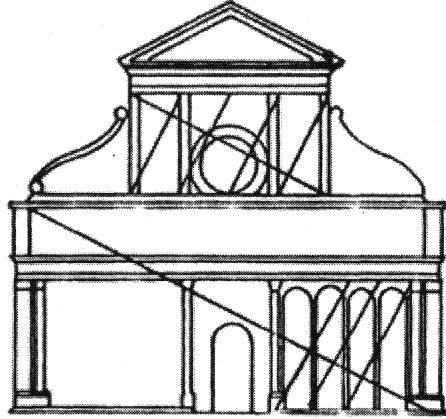

Figure 2: *Santa Maria Novella*

Given a rectangle of arbitrary proportions 1:x as shown in Figure 3a, draw the diagonal and then a line segment intersecting the first at right angles. This divides the original unit (U) into a smaller unit and a leftover rectangle referred to as a gnomon (G), i.e., $U = U + G$ as shown in Figure 3b. Of course this can be repeated to obtain a dissection of U into an arbitrary number of “whirling” gnomons and one leftover unit (see Figure 3c). The vertices of the gnomons lie on a logarithmic spiral as shown in Figure 3c.

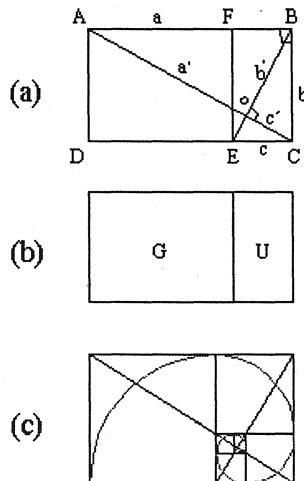

Figure 3: a) *The law of repetition of ratios; b) a unit divided into a unit (U) and a gnomon (G); c) vertex points from a logarithmic spiral.*

This concept has been popularized by the twentieth century designer Jay Hambridge who referred to it as dynamic symmetry [Hambridge 1929], [Edwards 1968]. In Figure 4a the law of repetition of ratios is applied to a golden rectangle of proportions 1: ϕ to obtain a gnomon equal to a square (S), i.e., $G = S$. In Figure 4b dynamic symmetry is applied to a rectangle of proportion 1: θ , referred to as a Roman rectangle, to obtain a gnomon of a double square, i.e., $G = S + S$. In Figure 4c, for a rectangle of proportions 1: ψ , we obtain $G = S + S + U$. For a rectangle of proportions 1: $\sqrt{2}$, $G = U$, i.e., if the root 2 rectangle is divided in half, two root 2 rectangles are created (see Figure 4d). For a rectangle of proportions 1: $\sqrt{3}$, $G = 2/3 U$, i.e., the unit is the 1/3 part of the original rectangle (Figure 4e).

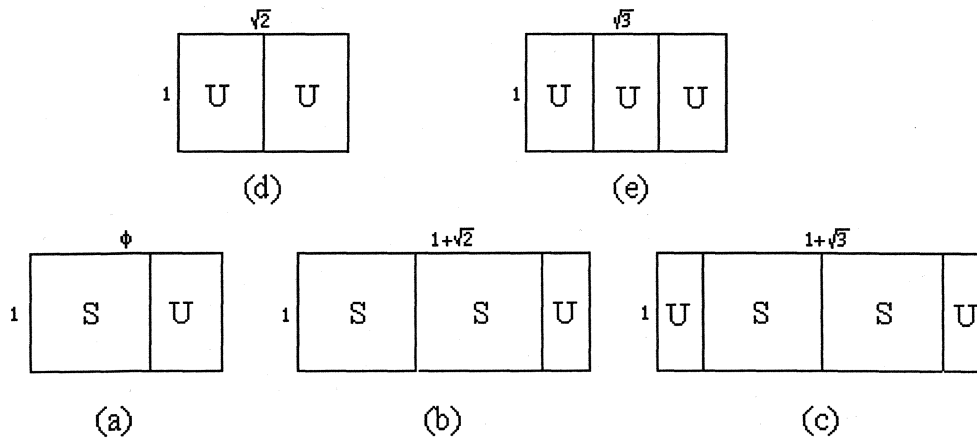

Figure 4: Law of repetition of ratios where the unit is a) a golden rectangle; b) a Roman rectangle; c) a $1 + \sqrt{3}$ rectangle; d) a root 2 rectangle; e) a root 3 rectangle.

4. Continued Fractions and Systems of Proportion

Any positive number, a , can be expanded as a continued fraction,

$$a = a_0 + 1/(a_1 + 1/(a_2 + 1/(a_3 + 1(\dots))))$$

where a_1, a_2, a_3, \dots are referred to as the indices of a . The continued fraction can be expressed by the notation $a = [a_0; a_1, a_2, a_3, \dots]$. Rational values of a have a finite number of indices while irrational values are represented by an infinite sequence of indices. Truncating the continued fraction at various levels leads to rational approximations of a known as *approximants*.

The golden mean satisfies the quadratic equation $x^2 - x - 1 = 0$, (2a)

which can be rewritten as $x = 1 + 1/x$ (2b)

Replacing x by its recursive definition in Equation 2b yields the continued fraction expansion, $\phi = [1; 1, 1, 1, \dots] = [1; \bar{1}]$, where $\bar{1}$ denotes the infinite repetition of the index 1. Truncating this series at different levels leads to the series of *approximants*,

$$1/1, 2/1, 3/2, 5/3, 8/5, 13/8, \dots$$

the ratio of successive terms of the Fibonacci, F-sequence:

$$1 \ 1 \ 2 \ 3 \ 5 \ 8 \ 13 \ 21 \ \dots$$

This series has the property : $a_{n+1} = a_{n-1} + a_n$. From Equation 2 it follows that $\phi^2 = \phi + 1$. From this it follows that the ϕ -sequence,

$$\dots \frac{1}{\phi} \frac{1}{\phi^2} 1 \phi \phi^2 \phi^3 \phi^4 \dots$$

is both a double geometric and a Fibonacci sequence.

The number ϕ is the basis of a one-dimensional model for quasicrystals having “forbidden” five-fold symmetry [Schroeder 1991]. The five-fold symmetry is illustrated by the laser diffraction pattern of Figure 5.

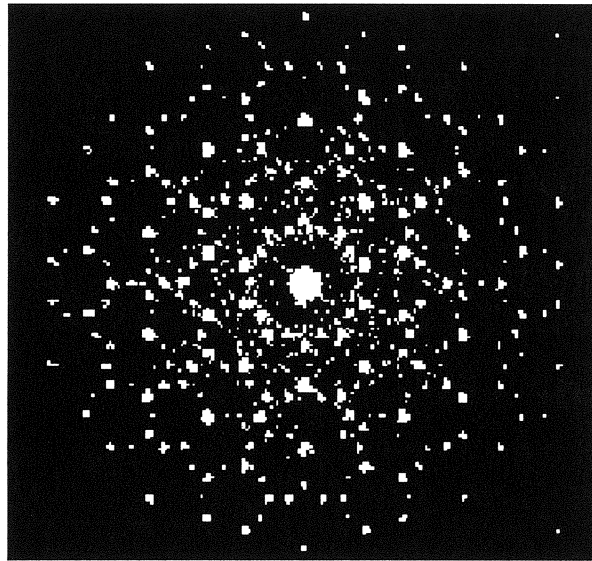

Figure 5: Laser diffraction pattern of a quasicrystal with five-fold symmetry

Any solution to the quadratic equation $x^2 - px - q = 0$ for $p > 0$, is the ratio of successive terms of a generalized Fibonacci sequence in the sense that

$$a_{n+1} = pa_n + qa_{n-1}. \tag{4}$$

If $q = 1$, the solution to the quadratic is referred to as the p -th *positive silver mean*, while if $q = -1$, the solution is said to be the p -th *negative silver mean*. Any value of $q \neq \pm 1$ has been referred to as the (p, q) -th *bronze mean* [Spinadel 1998] . For example, if $p = 2$ and $q = 1$, then $\theta = 1 + \sqrt{2}$ is the 2-nd positive silver mean corresponding to the continued fraction $\theta = [2 ; \bar{2}]$. The number θ is sometimes simply called the silver mean because it is second in importance to the golden mean in the study of dynamical systems. Clearly $\sqrt{2} = [1; \bar{2}]$ and has the following series of approximants:

$$1/1, 3/2, 7/5, 17/12, 41/29, \dots \tag{5}$$

which leads to the following pair of integer sequences :

$$\begin{matrix} 1 & 1 & 3 & 7 & 17 & 41 & 99 & \dots \\ 0 & 1 & 2 & 5 & 12 & 29 & 70 & \dots \end{matrix} \tag{6a}$$

32 Jay Kappraff

These generalized Fibonacci sequences are known as Pell sequences and were used as the basis of the ancient Roman system of proportions [Kappraff 1996]. They possess the additive property,

$$a_{n+1} = a_{n-1} + 2a_n \text{ where } \lim_{n \rightarrow \infty} a_{n+1}/a_n = \theta.$$

These additive properties are found in the pair of double geometric sequences,

$$\begin{array}{cccccccc} \dots & \sqrt{2}/\theta & \sqrt{2} & \sqrt{2}\theta & \sqrt{2}\theta^2 & \sqrt{2}\theta^3 & \sqrt{2}\theta^4 & \dots \\ \dots & 1/\theta & 1 & \theta & \theta^2 & \theta^3 & \theta^4 & \dots \end{array} \quad (6b)$$

Any arithmetical property possessed by the integer Sequence 6a is also possessed by the geometric Sequence 6b. For example,

$$\begin{array}{ll} 3 + 2 = 5, & \sqrt{2} + 1 = \theta, \\ 7 + 5 = 12, & \theta\sqrt{2} + \theta = \theta^2, \\ \\ 2 + 5 = 7, & 1 + \theta = \theta\sqrt{2}, \\ 5 + 12 = 17, & \theta + \theta^2 = \theta^2\sqrt{2}, \\ 1 + 3 + 1 + 2 = 7, & \sqrt{2}/\theta + \sqrt{2} + 1/\theta + \theta = \theta\sqrt{2}, \\ 3 + 7 + 2 + 5 = 17, & \sqrt{2} + \theta\sqrt{2} + 1 + \theta = \theta^2\sqrt{2}. \end{array}$$

Also each element of the lower Sequence of 6b is the arithmetical mean of the two terms of the upper sequence that brace it while each element of the upper series is the harmonic mean of the two terms from the lower series that brace it. Note that the harmonic mean m of x and y is defined as $m = 2xy/(x+y)$. The integer sequence 6a has the same property in an asymptotic sense.

In the context of quasicrystals, β leads to a one-dimensional model of a quasicrystal with a “forbidden” eight-fold rotational symmetry first described by Wang, Chen, and Kuo [1987].

5. The Root 3 System of Proportions

If $p = 2$ and $q = 2$ in Equation 4, then the bronze mean, $\psi = 1 + \sqrt{3}$, is a solution corresponding to $\psi = [2; 1, 2]$. A proportional system based on $\sqrt{3}$ is derived from the continued fraction expansion, $\sqrt{3} = [1; 1, 2]$ with the following series of approximants:

$$1/1 \quad 2/1 \quad 5/3 \quad 7/4 \quad 19/11 \quad 26/15 \quad 71/41 \quad 97/56 \dots \quad (7)$$

leading to the double integer sequence,

$$\begin{array}{cccccccc} 1 & 2 & 5 & 7 & 19 & 26 & 71 & 97 \dots \\ 1 & 1 & 3 & 4 & 11 & 15 & 41 & 56 \dots \end{array} \quad (8a)$$

These sequences share aspects of both the Fibonacci and Pell sequences in that ,

$$\begin{array}{l} 1 + 2 \times 2 = 5, \quad 2 + 5 = 7, \quad 5 + 2 \times 7 = 19, \quad 7 + 19 = 26, \text{ etc.} \\ 1 + 2 \times 1 = 3, \quad 1 + 3 = 4, \quad 3 + 2 \times 4 = 11, \quad 4 + 11 = 15, \text{ etc.} \end{array}$$

They also have other additive properties such as,

$$\begin{aligned} 2 + 1 &= 3, \quad 7 + 4 = 11, \quad 26 + 15 = 41, \text{ etc.} \\ 3 + 4 &= 7, \quad 11 + 15 = 26, \quad 41 + 56 = 97, \text{ etc.} \end{aligned}$$

The corresponding additive properties of Sequence 8a are also found in the pair of double geometric sequences,

$$\begin{aligned} \dots \sqrt{3}/\alpha \quad \sqrt{3} \quad \sqrt{3}\alpha \quad \sqrt{3}\beta \quad \sqrt{3}\beta^2 \quad \sqrt{3}\alpha\beta \quad \sqrt{3}\beta^3 \quad \sqrt{3}\alpha\beta^3 & \quad (8b) \\ \dots 1/\alpha \quad 1 \quad \alpha \quad \beta \quad \alpha\beta \quad \beta^2 \quad \alpha\beta^2 \quad \beta^3 \quad \alpha\beta^3 & \end{aligned}$$

where $\alpha = \psi/2$ and $\beta = \psi^2/2$. Analogous to Sequences 8a, Sequences 8b have the following additive properties:

$$1 + 2\alpha = \beta, \quad \alpha + \beta = \alpha\beta, \quad \alpha + \sqrt{3}\alpha = \beta, \quad 1 + \alpha = \sqrt{3}\alpha, \quad 1 + 2\sqrt{3}\beta = \beta^2 \quad (9)$$

It should be noted that $\beta = 2 + \sqrt{3}$ is the 4-th negative silver mean, i.e., it satisfies Equation 4a for $p = 4$ and $q = -1$ and can be expressed as the following continued fraction with negative entries,

$$\beta = 4 - 1/(4 - 1/(4 - 1/(4 - 1/(...))))$$

The approximants of this sequence : $4/1, 15/4, 56/15, \dots$ are found in the terms of Sequence 8a and 8b related to powers of β . The proportion β is the basis for generating quasicrystals with the forbidden twelve-fold symmetry [Chen 1988].

A second pair of double geometric sequences and their accompanying integer sequence shed light on this system of proportions,

$$\dots \sqrt{3}/\psi \quad \sqrt{3} \quad \sqrt{3}\psi \quad \sqrt{3}\psi^2 \quad \sqrt{3}\psi^3 \quad \sqrt{3}\psi^4 \dots \quad (10a)$$

and,

$$\begin{array}{cccccccc} 1 & 1 & 4 & 10 & 28 & 76 & 208 & \dots \\ 0 & 1 & 2 & 6 & 16 & 44 & 140 & \dots \end{array}$$

Each of Sequences 10a and 10b are Generalized Fibonacci sequences with the additive property,

$$a_{n+1} = 2(a_{n-1} + a_n). \quad (11)$$

Also the ratio of successive terms in each sequence of Sequence 10b has the property

$$\lim_{n \rightarrow \infty} a_{n+1}/a_n = \psi \quad \text{and} \quad \lim_{n \rightarrow \infty} b_{n+1}/b_n = \psi \quad \text{while} \quad \lim_{n \rightarrow \infty} b_n/a_n = \sqrt{3}.$$

Whereas each term from the lower sequence divides the two terms from the upper sequence that brace it in a ratio of 1: 2, e.g., $2(16 - 10) = 28 - 16$, each term from the upper sequence is the harmonic means of the two terms from the lower sequence that brace it in an asymptotic sense, and divides this interval in a ratio which asymptotically approaches $\alpha = 1.366\dots$, e.g., $(140-76)/(76-44) = 11/8 \approx 1.375$ where 76 is approximately the harmonic mean of 44 and 140. The same property holds exactly for Sequence 10a. As an example of the additive properties of the root 3 system, consider edge AB of the twelve pointed star shown in Figure 1c. Taking the edge of the dodecagon to be 1 unit and using Equation 9, the length of the longest diagonal AB is,

$$AB = 1 + 1/\psi + 1 + 1/\psi + 1 = \alpha + 1 + \alpha = \beta$$

and, using Equation 11, the diagonals intersect in the ratio $1/(1/\psi + 1 + 1/\psi + 1) = 1/\psi$.

6. A Dynamical Systems Approach to Proportions

Consider a rectangle of proportions 1:x subdivided according to the law of repetition of ratios into a unit of the same ratio and a gnomon (see Figure 6a). In Figure 6b a square placed into this rectangle produces a pair of proportions $1/x$ and $1-1/x = (x-1)/x = 1/y$ where $1/x + 1/y = 1$. If x and y are irrational numbers then we can apply Beatty's Theorem.

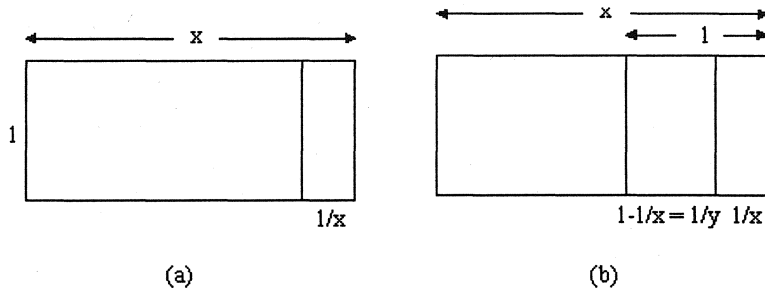

Figure 6: a) Law of repetition of ratios; b) production of ratios $1/x$ and $1/y$.

Theorem (Beatty's): If x and y are irrational numbers such that $1/x + 1/y = 1$ (Beatty pairs), then the set $\{ [nx], [ny] \text{ for } n = 1, 2, 3, \dots \}$, where $[]$ denotes "the integer part of", equals the set of natural numbers with no repeats.

The following Beatty pairs correspond to the golden mean, root 2, and root 3 systems of proportion, respectively: 1) $x = \phi, y = \phi^2$; 2) $x = \sqrt{2}, y = \theta\sqrt{2}$; and 3) $x = \sqrt{3}, y = \alpha\sqrt{3}$. Table 1 illustrates Beatty's Theorem for the $\sqrt{3}$ system.

n	$[n\sqrt{3}]$	$[n\alpha\sqrt{3}]$
1	1	2
2	3	4
3	5	7
4	6	9
5	8	11
6	10	14
⋮	⋮	⋮

If the numbers in column 2 are assigned a 1 while the numbers in column 3 are assigned a 0, the numbers in Table 1 are listed in order as

$$1010110101011010101 \dots \tag{12a}$$

This sequence is known in the theory of dynamical systems as the symbolic dynamics. Notice that it contains all the information concerning the approximating series to $\sqrt{3}$ given by Sequence 8a. For example 1/2 of the first two numbers in Sequence 12a are 1's, 3/5 of the first five numbers are 1's, 11/19

of the first 19 numbers are 1's, etc. In a similar manner the symbolic dynamics for the ϕ system and the $\sqrt{2}$ system are:

$$\phi: \quad 1 \ 0 \ 1 \ 1 \ 0 \ 1 \ 0 \ 1 \ 1 \ 0 \ 1 \ 1 \ 0 \ 1 \ 0 \ 1 \ 1 \ 1 \dots \quad (12b)$$

and,

$$\sqrt{2}: \quad 1 \ 1 \ 0 \ 1 \ 1 \ 0 \ 1 \ 1 \ 1 \ 0 \ 1 \ 1 \ 0 \ 1 \ 1 \ 1 \ 0 \dots \quad (12c)$$

These also replicate their approximating Sequences 3 and 5.

The symbolic dynamics can also be generated by drawing a line with slope x/y on a coordinate system with vertical and horizontal lines drawn at integer values of the coordinates. Where this line cuts a vertical coordinate line assign a 1; where it crosses a horizontal coordinate line assign a 0. The symbolic dynamics for the ϕ , $\sqrt{2}$, and $\sqrt{3}$ systems is illustrated in this manner in Figure 7. The ratio, $1/x$, can be thought of as the probability of getting a 0 in the above sequence while $1/y$ is the probability of getting a 1, in which case the slope of the line represents the odds of getting a 0.

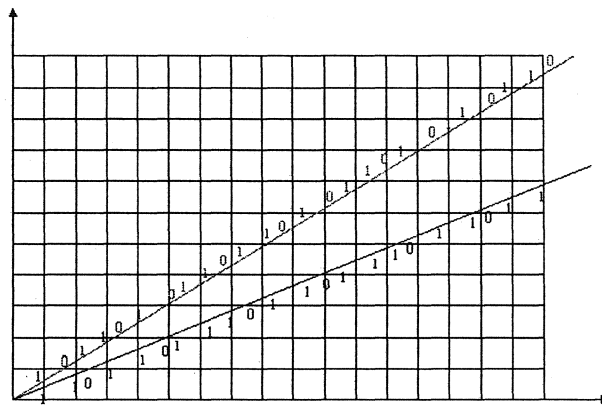

Figure 7a: Square lattice and straight line with slope $x/y = 1/\phi$ generates the approximating sequence (10110...) to ϕ . The lower straight line has slope $x/y = 1/\theta$ and generates another self-similar approximating binary sequence to $\sqrt{2}$

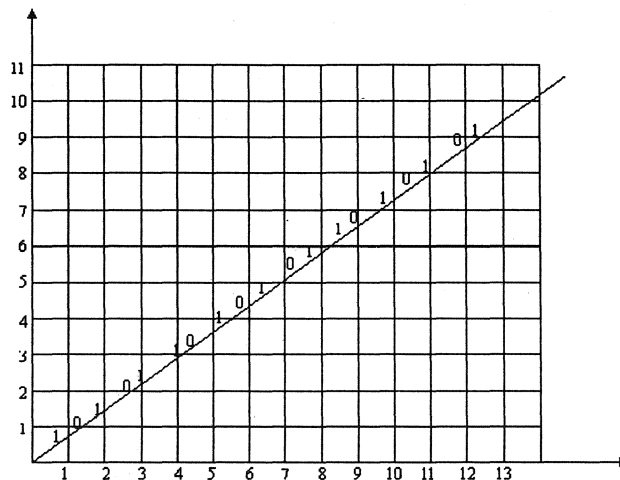

Figure 7b: Square lattice and straight line with slope $x/y = 1/\alpha$ generates the $\sqrt{3}$ approximating sequence.

7. Geometry of the Root 3 System

Perhaps the most fundamental place that the $\sqrt{3}$ makes its appearance is in a figure referred to in sacred geometry as the Vesica Pisces. Draw a circle. Place a point on the circumference and draw a second circle of the same radius as the first (see Figure 8a).

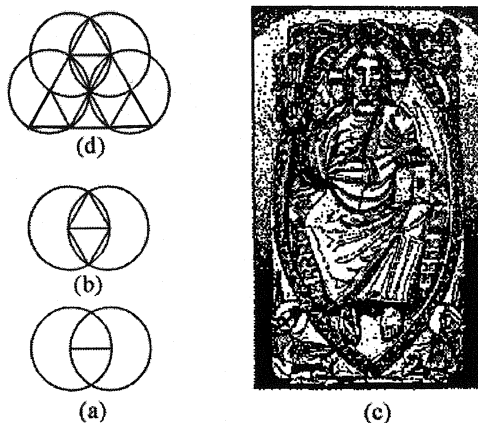

Figure 8: a) Vesica Pisces; b) two equilateral triangles in a Vesica; c) image of Christ in a Vesica Pisces; d) tetractys

The region in common to the two circles has a length and width in proportions $\sqrt{3}:1$ within which two equilateral triangles may be inscribed (see Figure 8b). It is in this central region that images of Christ were often placed (see Figure 8c). Four intersecting circles create a triangular grid of ten vertices known in ancient times as the tetractys (see Figure 8d). Figure 9 shows a six pointed star with edges intersecting in the ratio 1:2.

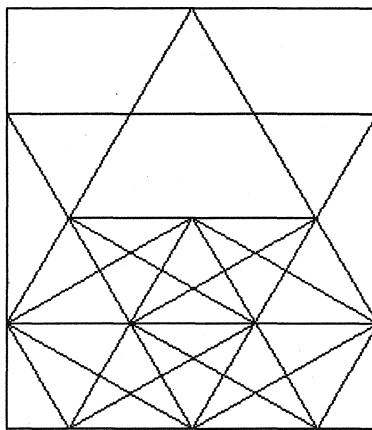

Figure 9: Hexagonal grid illustrating the root 3 system

Notice that numerous $1:\sqrt{3}$ rectangles and star hexagons at smaller scales are defined by this construction. Also notice that 30, 60, 90-triangles are defined by this star.

In Figure 10 a rectangle with proportions $1: \psi$ is tiled by a triangular grid with a small rectangular strip leftover.

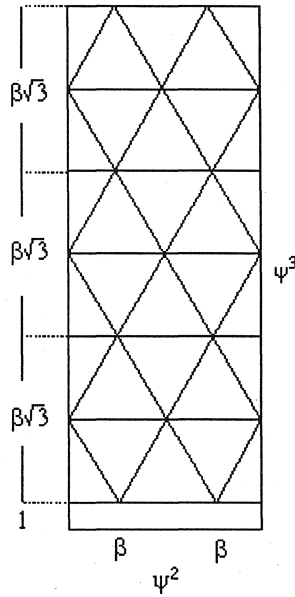

Figure 10: Rectangle with proportions $1: \psi$ tiled by a triangular grid with a rectangular strip left over.

Figures 11a and 11b shows two examples in which the $\sqrt{3}$ and $\sqrt{2}$ geometry are combined : 1) a right triangle whose hypotenuse is the body diagonal and the two sides are the edge and face diagonal of a cube; and 2) a rectangle discovered by Doug Ailles, a high school teacher at Etobicoke Collegiate Institute in Etobicoke, Ontario, including a 15, 75, 90 deg. right triangle with sides $\psi/\sqrt{2}$, $\sqrt{2}/\psi$, and 2 [Vakil 1996]. Other designs with root 3 geometry are shown in Figure 12 [Edwards 1968].

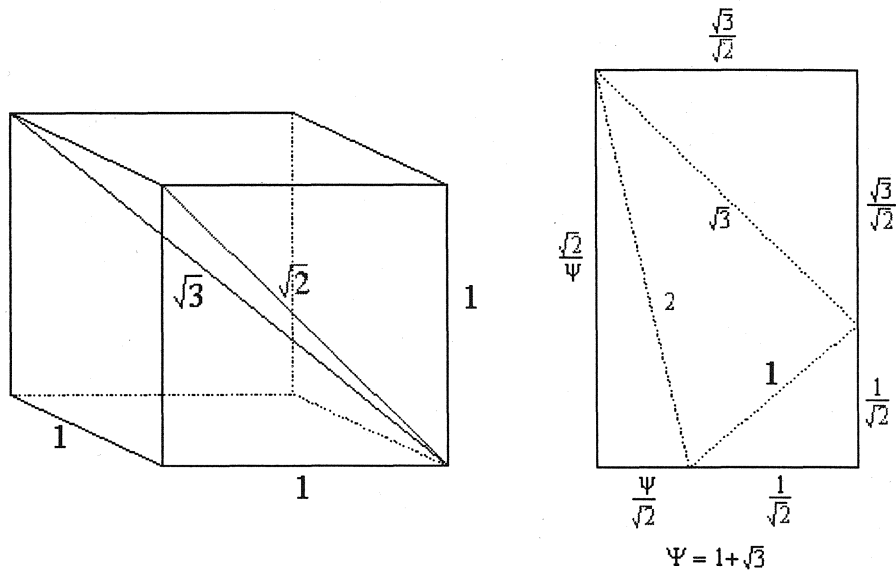

Figure 11: a) Root 2 and root 3 are combined in a) a cube; b) an Ailles rectangle.

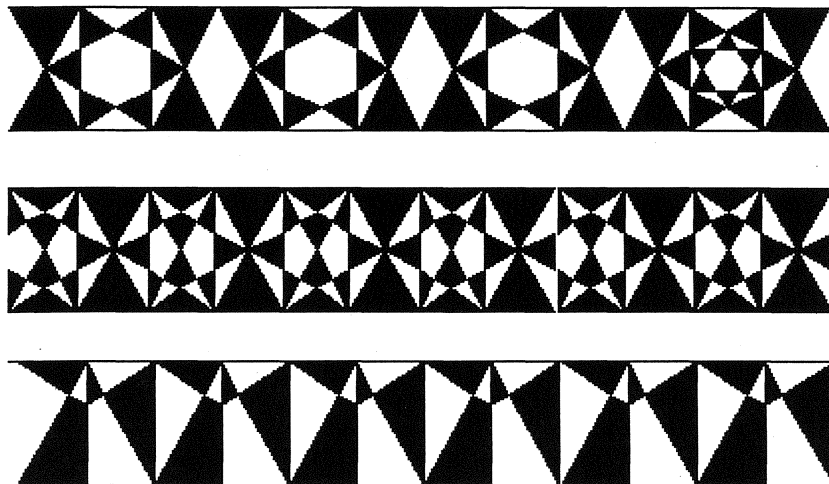

Figure 12: *Some root 3 patterns from Patterns and Designs with Dynamic Symmetry by E. Edward. Courtesy of Dover Press.*

Coxeter [1973] has shown that the fundamental domain of the group of symmetries in the plane generated by three mirrors can be either an equilateral triangle, 45 degree isosceles triangle, or 30, 60, 90 degree triangle. Except for rectangular and square fundamental regions, the fundamental domains of all symmetries of the plane are subsets of these triangles as provided by the root 2 and root 3 proportional systems. The more recent development of five-fold quasicrystal symmetry as exhibited by Penrose tilings, such as the one shown in Figure 13, makes use of the ϕ -system of proportions.

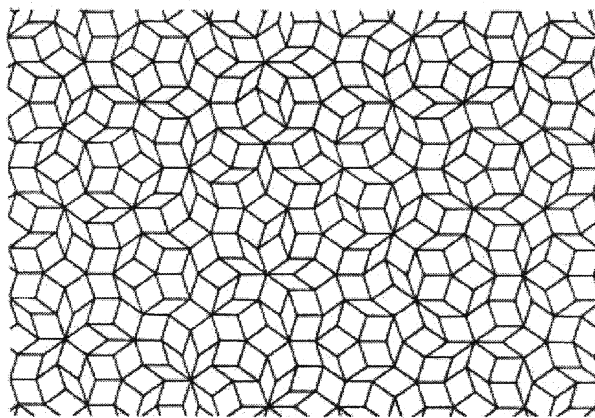

Figure 13: *A Penrose tiling which approximates 5-fold symmetry.*

8. Palladio's Villas

There is evidence that the great architect of the Italian Renaissance, Andreas Palladio used the root 3 proportional system in his designs [Wasson 1998]. In the four large corner rooms of Villa Rotunda, each corner room has length and width in the ratio 26 by 15 which according to Sequence 8a is an approximation to $\sqrt{3}$. On the other hand, the height is the arithmetical mean of 15 and 26 or $41/2$, so that

the height to width ratio is $41/2 : 15 = 1.366... \approx a$. Mitrovic [1990] uncovered the fact that the four smaller rectangular rooms of the Villa Rotunda are related to the large corner rooms. Each smaller room has dimension $15 : 11 = 1.3636... \approx a$, another ratio found in Sequence 8a.

9. Conclusion

The root 2 system of architecture had its roots in the architecture of ancient Rome and the Italian Renaissance. We have found that a root 3 geometry was also used during the Renaissance while a system of proportion based on the golden mean was used by the twentieth century architect, Le Corbusier. The first two systems can be shown to be based on the symmetry groups of the plane while the third system, based on the golden mean, is the basis of quasicrystal geometries depicted in two-dimensional projections as Penrose tilings of the plane. We have also shown that these proportional systems give rise to numbers of importance to the study of dynamical systems.

Acknowledgments

This paper owes much to Kim Williams who first called my attention to the root 3 sequence. I am also indebted to Asim Riaz for help in preparing the text.

Note: This paper was submitted simultaneously for a presentation at the Bridges Conference and for publication in the electronic journal of Visual Mathematics (<http://members.tripod.com/vismath/>)

Bibliography

Chen, H., Li, D.X., and Kuo, K.H. "New type of two-dimensional quasicrystal with twelvefold rotational symmetry." *Phys. Rev. Lett.* 60, pp1645-1648.

Coxeter, H.S.M. *Regular Polytopes*. New York: Dover (1973).

Edwards, E. B. *Pattern and Design with Dynamic Symmetry*. Originally published as *Dynamarhythmic Design* (1932) (rpt. New York: Dover 1968).

Hambridge, J. *The Elements of Dynamic Symmetry*. Originally published by Brentano's (1929) (rpt. by New York: Dover).

Kappraff, J. *Connections: The Geometric Bridge between Art and Science*. New York: McGraw-Hill (1991).

Kappraff, J. "Musical Proportions at the Basis of Systems of Proportion Both Old and New." In *Nexus: Architecture and Mathematics* edited by K. Williams. Fecechio, Italy: Edizioni Dell'Erba (1996a).

Kappraff, J. "Linking the Musical Proportions of the Renaissance with the Modulor of Le Corbusier and the System of Roman Proportions." *International Journal of Space Structures*, Vol. 11, No. 1 and 2 (1996b).

Kappraff, J. *Mathematics Beyond Measure*. New York: Plenum Press (in press).
Le Corbusier. *Modulor*. Cambridge: MIT Press (1968).

Mitrovic, B. "Palladio's theory of Proportions and the Second Book of the *Quattro Libri dell'Architettura*." *Journal of the Soc. of Arch. Hist.* 49, 3 pp 281-285 (Sept. 1990).

Nicholson, B., Kappraff, J., and Hisano, S. "A Taxonomy of Ancient Geometry and the Hidden Pavements of the Laurentian Library." *Proceedings, Bridges: Mathematical Connections in Art, Music, and Science*, edited by Reza Sarhangi, PP 255-271 (1998)

Schroeder, M. *Fractals, Chaos, Power Laws*. New York: W.H. Freeman (1991).

De Spinadel, V.W. *From the Golden Mean to Chaos*. Self published ISBN 950-43-9329-1 (1998).

Vakil, R. *A Mathematical Mosaic - Patterns and Problem Solving*. Burlington, Ontario: Brendan Kelly Publ. Inc. (1996).

Wassell, S.R. "The Mathematics of Palladio's Villas." In *Nexus: Architecture and Mathematics*. Fucechio: Edizioni Dell'Erba (1998).

Wang, N., Chen, H., and Kuo, L.H. "Two dimensional quasicrystal with eight-fold rotational symmetry." *Phys. Rev. Lett.* 59, pp 1010-1013.

Williams, K. "Michelangelo's Medici Chapel: the cube, the square and the $\sqrt{2}$ rectangle." *Leonardo*. Vol 30, No. 2 (1997).

Wittkover, R. *Architectural Principles in the Age of Humanism*. New York: Norton (1971).